



1- Purchasing information

P.O. number:* _____ Date: _____

Company Name:* _____

Purchasing contact:* _____

Phone:* _____

Email:* _____

Contact preference:* Phone Email

Marked for: _____

2- ATP/Clinician information

ATP/Clinician:* _____

Phone:* _____

Email:* _____

Contact preference:* Phone Email

3- Shipping information

Ship to:* _____

Name: _____

Address: _____

City: _____ State: _____

Zip Code: _____

Phone: _____

* Required MA082 English Manual (STD) MA089 Spanish Manual Taxes not included

MODEL				USD		
WC11	<input type="checkbox"/>	Ultralight Aluminum APEX Rigid Wheelchair (265 lb weight limit) <i>Not available with painted frame - Frame will be black</i>	Triple-butted aluminum frame / Aluminum back canes and back rigidizer / Aluminum seat rigidizer / Ultralight carbon fiber camber tube and rear frame rigidizer	K0005	\$2,595	
WC21	<input type="checkbox"/>	Apex Carbon fiber frame upgrade (High Gloss Carbon Fiber)	Ultralight carbon fiber frame, back canes, back rigidizer, seat rigidizer, camber tube and rear frame rigidizer.		\$2,450	
Frame						
SEAT WIDTH						
SW	<input type="checkbox"/>	12" <input type="checkbox"/>	13" <input type="checkbox"/>	14" <input type="checkbox"/>	15" <input type="checkbox"/>	
	<input type="checkbox"/>		20" <input type="checkbox"/>	16" <input type="checkbox"/>	17" <input type="checkbox"/>	
				18" <input type="checkbox"/>	19" <input type="checkbox"/>	
					E2201	
					NC	
					\$505	
SEAT DEPTH						
SD	<input type="checkbox"/>	12" <input type="checkbox"/>	13" <input type="checkbox"/>	14" <input type="checkbox"/>	15" <input type="checkbox"/>	
	<input type="checkbox"/>		20" <input type="checkbox"/>	16" <input type="checkbox"/>	17" <input type="checkbox"/>	
				18" <input type="checkbox"/>	19" <input type="checkbox"/>	
					E2203	
					NC	
					\$485	
FRAME LENGTH						
SP01	<input type="checkbox"/>	Standard frame length configuration ¹				STD
SP02	<input type="checkbox"/>	Frame length 1" longer than standard configuration				NC
SP03	<input type="checkbox"/>	Frame length 2" longer than standard configuration				NC
SP04	<input type="checkbox"/>	Frame length 1" shorter than standard configuration				NC
SP05	<input type="checkbox"/>	Frame length 2" shorter than standard configuration				NC
TIE-DOWN						
AC05-S	<input type="checkbox"/>	WC-19 Transit Tie Down w/Q straint belt ^{2,3}	Short belt 20"-41"		\$365	
AC05-L	<input type="checkbox"/>	WC-19 Transit Tie Down w/Q straint belt ^{2,3}	Long belt 20"-46"		\$365	
AC35	<input type="checkbox"/>	WC-19 Transit Tie Down without belt ³				\$335

1- Distance of 4.37" from end of seat upholstery to bend

2- Not available with depth adjustable back; 3- May interfere with the swing away armrest and the clamp on height adjustable push handle; Add a 3" of frame length behind backrest

FRONT Seat-to-floor height		
Caster sizes	Height available +- 1/4"	
<input type="checkbox"/> 3" Caster	14" to 21"	
<input type="checkbox"/> 4" Caster	14.5" to 21"	
<input type="checkbox"/> 5" Caster	15.5" to 21"	
<input type="checkbox"/> 6" Caster	16.5" to 21" (N/A with 90° front frame)	

Specify desired height:

_____ (inches)

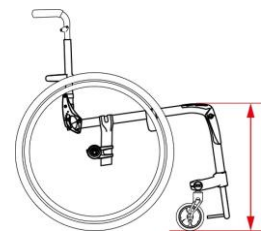

CASTERS				Available	
CA01-03 to CA01-06	<input type="checkbox"/>	Composite wheel w/ PU tire (1")		3", 4", 5", 6"	NC
CA10	<input type="checkbox"/>	Pneumatic casters (1 ¼")		6"	\$165
CA14 to CA16	<input type="checkbox"/>	Newton UltraCaster Composite (1 ½ ")		4", 5", 6"	\$95
CA17 to CA19	<input type="checkbox"/>	Newton UltraCaster Aluminum (1 ½ ")		4", 5", 6"	\$215
CASTER OPTIONS					
CA13	<input type="checkbox"/>	Carbon fiber Frog Legs suspension forks		E1015	\$490

REAR Seat-to-floor height		
Wheel sizes	Height available +- 1/4"	
<input type="checkbox"/> 20" (451) wheel	14" to 17.5"	
<input type="checkbox"/> 22" (501) wheel	14" to 18.5"	
<input type="checkbox"/> 24" (540) wheel	15" to 19.5"	
<input type="checkbox"/> 25" (559) wheel	15.5" to 20"	
<input type="checkbox"/> 26" (590) wheel	16" to 20"	

Specify desired height: _____ (inches)

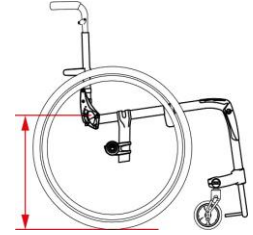

FRONT FRAME ANGLE			
FA70	<input type="checkbox"/>	70° Front frame angle	NC
FA75	<input type="checkbox"/>	75° Front frame angle	NC
FA80	<input type="checkbox"/>	80° Front frame angle	NC
FA85	<input type="checkbox"/>	85° Front frame angle	NC
FA90	<input type="checkbox"/>	90° Front frame angle	NC

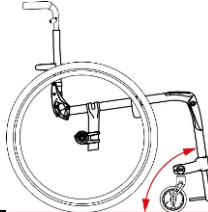

Seat upholstery to footplate length	
12" to 19" without high mount	Specify desired length: _____ (inches)
7" to 13" with high mount ¹	<i>Required</i>

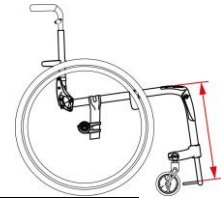

1- Choose high mount in the footplates section

Footrest width / Taper selection				
Seat Width	Straight	1" Taper	2" Taper	
Outside Measurement	2 ½" Narrower than Seat Width	4 ½" Narrower than Seat Width	6 ½" Narrower than Seat Width	
12"	9.5" <input type="checkbox"/>	7.5" <input type="checkbox"/>		
13"	10.5" <input type="checkbox"/>	8.5" <input type="checkbox"/>		
14"	11.5" <input type="checkbox"/>	9.5" <input type="checkbox"/>		
15"	12.5" <input type="checkbox"/>	10.5" <input type="checkbox"/>		
16"	13.5" <input type="checkbox"/>	11.5" <input type="checkbox"/>	9.5" <input type="checkbox"/>	
17"	14.5" <input type="checkbox"/>	12.5" <input type="checkbox"/>	10.5" <input type="checkbox"/>	
18"	15.5" <input type="checkbox"/>	13.5" <input type="checkbox"/>	11.5" <input type="checkbox"/>	
19"	16.5" <input type="checkbox"/>	14.5" <input type="checkbox"/>	12.5" <input type="checkbox"/>	
20"	17.5" <input type="checkbox"/>	15.5" <input type="checkbox"/>	13.5" <input type="checkbox"/>	

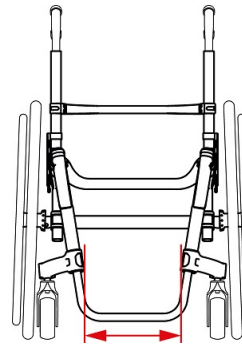

Note: higher than 20" Front STFH will reduce the footrest width up to 1" with a 2" taper

FOOTPLATES			
FP12	<input type="checkbox"/>	Tubular open loop ¹	STD
FP13	<input type="checkbox"/>	Tubular with ABS cover	K0040 NC
FP31	<input type="checkbox"/>	Adjustable angle - Aluminum (<i>one piece</i>)	K0040 \$97
FP32	<input type="checkbox"/>	Newton adjustable angle - Carbon fiber (<i>one piece with rubber inserts</i>)	K0040 \$190
FP14	<input type="checkbox"/>	Flip back, adjustable angle aluminum	K0040 \$200
FP15	<input type="checkbox"/>	Flip back, adjustable angle carbon fiber	\$295
FR25	<input type="checkbox"/>	High mount with adjustable angle footplate (<i>Aluminum - one piece</i>)	K0040 \$170
FR26	<input type="checkbox"/>	High mount with adjustable angle footplate (<i>Carbon fiber with rubber inserts - one piece</i>)	\$250

FOOTPLATES ACCESSORIES			
FP16	<input type="checkbox"/>	2" riser (<i>only available with aluminum angle adjustable footplate</i>) ²	\$77
FP09	<input type="checkbox"/>	Calf strap	K0038 \$36
FP30	<input type="checkbox"/>	Bodypoint Aeromesh Padded calf strap	K0038 \$118

1 - Available on: all straight frames; 1" taper with seat width of 14" and greater; 2" taper with seat width of 16" and greater

2- Not available with high mount

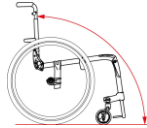
Backrest											
FOLD DOWN BACKREST											
BC20	<input type="checkbox"/>	Locking backrest			STD						
BC21	<input type="checkbox"/>	Ultralight non locking backrest (not locking in upright and down position) ²			\$102						
FIXED HEIGHT, ADJUSTABLE ANGLE FOLD DOWN BACKREST (Not available with push handles)											
BC	<input type="checkbox"/>	Fixed height without push handle	(30) 9" <input type="checkbox"/>	(31) 9.5" <input type="checkbox"/>	(32) 10" <input type="checkbox"/>	(33) 10.5" <input type="checkbox"/>	(34) 11" <input type="checkbox"/>	NC			
		(35) 11.5" <input type="checkbox"/>	(36) 12" <input type="checkbox"/>	(37) 12.5" <input type="checkbox"/>	(38) 13" <input type="checkbox"/>	(39) 13.5" <input type="checkbox"/>	(40) 14" <input type="checkbox"/>		(41) 14.5" <input type="checkbox"/>		
		(42) 15" <input type="checkbox"/>	(43) 15.5" <input type="checkbox"/>	(44) 16" <input type="checkbox"/>	(45) 16.5" <input type="checkbox"/>	(46) 17" <input type="checkbox"/>	(47) 17.5" <input type="checkbox"/>		(48) 18" <input type="checkbox"/>		
		(49) 18.5" <input type="checkbox"/>	(50) 19" <input type="checkbox"/>	(51) 19.5" <input type="checkbox"/>	(52) 20" <input type="checkbox"/>	(53) 20.5" <input type="checkbox"/>	(54) 21" <input type="checkbox"/>				
HEIGHT AND ANGLE ADJUSTABLE FOLD DOWN BACKREST WITH PUSH HANDLE OPTIONS (MUST select ONE push handle options)											
BC	<input type="checkbox"/>	Straight back canes	(22) 9 - 12" <input type="checkbox"/>	(23) 12 - 15" <input type="checkbox"/>	(24) 15 - 18" <input type="checkbox"/>	(25) 18 - 21" <input type="checkbox"/>		NC			
Set height to: *		(in increments of 1/2", measured from seat sling to top of back upholstery) * If not indicated, default height setting is at the lowest position									
Select back cane angle: ¹		101° <input type="checkbox"/>	99° <input type="checkbox"/>	96° <input type="checkbox"/>	93° <input type="checkbox"/>	90° <input type="checkbox"/>	87° <input type="checkbox"/>	83° <input type="checkbox"/>	80° <input type="checkbox"/>		STD

1 - If not indicated default angle setting is at 93°; 2 - Maximum back cane height of 19.5" with the aluminum chair

PUSH HANDLES OPTIONS (ONE option at a time)					
PH01	<input type="checkbox"/>	Push handles			STD
PH05	<input type="checkbox"/>	Fold down push handles			\$145
PH06-920	<input type="checkbox"/>	Clamp on height adjustable push handles 9 - 20" ¹			\$325
PH06-923	<input type="checkbox"/>	Clamp on height adjustable push handles 9 - 23" ¹			\$325
PH02	<input type="checkbox"/>	Omit push handles			NC

1 - Not compatible with swing away armrests;

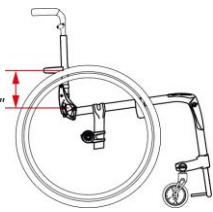
BACKRESTS OPTIONS					
BC61	<input type="checkbox"/>	Depth adjustable back - 1" depth adjustment ^{1,4}			\$195
BC62	<input type="checkbox"/>	Depth adjustable back - 2" depth adjustment ^{2,4}			\$195
BC56	<input type="checkbox"/>	Depth adjustable back - 3" depth adjustment ^{3,4}			\$195
BC57	<input type="checkbox"/>	Standard 3 inch deep rigidizer bar			STD
BC55	<input type="checkbox"/>	Four inch deep Aluminum rigidizer bar			NC
BC88	<input type="checkbox"/>	Custom height rigidizer bar set at _____ (inches)			\$135
		Measured from the top of the seat sling to the center of the rigidizer - standard height is 5,7" Lowest position is 4,25"			

If used in combination with WC-19: 1- Maximum depth of 19"; 2- Maximum depth of 18"; 3- Maximum depth of 17"; 4- Only compatible with WC-19 transit tie down **without** Q'Straint belt

BACK UPHOLSTERY					
BH03	<input type="checkbox"/>	Slip-on Syntech-Suede back upholstery			STD
BH04	<input type="checkbox"/>	Adjustable tension Syntech-Suede back upholstery		E2611	\$305
BH99	<input type="checkbox"/>	Omit Back upholstery			NC
	<input type="checkbox"/>	NXT back Support		See price list	
SEAT CUSHION					
SC01	<input type="checkbox"/>	2" Cushion			\$170
SC02	<input type="checkbox"/>	3" Cushion			\$190
SC99	<input type="checkbox"/>	Omit seat cushion			STD
	<input type="checkbox"/>	NXT cushion		See price list	

Rear wheels					
REAR WHEELS				Available	
RW01	<input type="checkbox"/>	Mag ¹		20", 22" 24"	\$57
RW02	<input type="checkbox"/>	Newton One - spoke wheel ²		20", 22" 24"	STD
RW03	<input type="checkbox"/>	Newton Gravity - ultralight wheel		20", 22", 24", 25", 26"	\$360
RW04	<input type="checkbox"/>	Spinergy Spox	Blk STD <input type="checkbox"/> Wht ³ <input type="checkbox"/> Blue ³ <input type="checkbox"/> Red ³ <input type="checkbox"/> Yel ³ <input type="checkbox"/>	22", 24", 25", 26"	\$915
RW05	<input type="checkbox"/>	Spinergy LX	Blk STD <input type="checkbox"/> Pur ³ <input type="checkbox"/> Wht ³ <input type="checkbox"/> Blue ³ <input type="checkbox"/> Red ³ <input type="checkbox"/> Yel ³ <input type="checkbox"/> Pink ³ <input type="checkbox"/> Grn ³ <input type="checkbox"/> Org ³ <input type="checkbox"/>	22", 24", 25", 26"	\$1,145
RW07	<input type="checkbox"/>	Spinergy CLX ⁴	Blk STD <input type="checkbox"/> Pur ³ <input type="checkbox"/> Wht ³ <input type="checkbox"/> Blue ³ <input type="checkbox"/> Red ³ <input type="checkbox"/> Yel ³ <input type="checkbox"/> Pink ³ <input type="checkbox"/> Grn ³ <input type="checkbox"/> Org ³ <input type="checkbox"/>	24", 25"	\$1,625
TIRES				Available	
Solid					
TI01	<input type="checkbox"/>	Soft Urethane 1 3/8"		20", 22" 24"	E2218 NC
TI02	<input type="checkbox"/>	Soft Urethane knobby 1 3/8" ⁵		22", 24", 25", 26"	E2218 \$97
TI04	<input type="checkbox"/>	Soft Urethane 1" - Shox		22", 24", 25", 26"	E2218 \$118
Pneumatic					
TI05	<input type="checkbox"/>	Pneumatic 1 3/8"		20", 22", 24", 25", 26"	E2211/E2212 STD
TI08	<input type="checkbox"/>	Pneumatic with Airless insert 1 3/8" ⁶		22", 24", 26"	E2211/E2213 \$82
TI06	<input type="checkbox"/>	Pneumatic HP, Low Tread, Puncture resistant, black 1" - SpeedLite		20", 22", 24", 25", 26"	E2211/E2212 \$105
TI07	<input type="checkbox"/>	Pneumatic HP, Medium Tread, Puncture resistant, black 1" - TrailBlazer		24", 25", 26"	E2211/E2212 \$150

1- Not compatible with HP tires; Only available with aluminum or plastic coated handrim in standard position; 2- Not compatible with Shox tires; 3- Colour spokes require an additional 10 days lead-time; 4- Only available with 1" tires; 5- The 22" is only available with Mags and Newton One rear wheels; 6- Not available with Spinergy CLX, Spinergy LX 25", 26" and Spox 25", 26" rear wheels

Handrims					
HANDRIM				Available	
HR01	<input type="checkbox"/>	Aluminum anodized		20", 22", 24", 25", 26"	STD
HR61	<input type="checkbox"/>	Aluminum black hard anodized ²		20", 22", 24", 25"	\$75
HR02	<input type="checkbox"/>	Plastic coated ¹		20", 22", 24", 25", 26"	\$110
HR03	<input type="checkbox"/>	High friction coated ^{1,2}		22", 24", 25", 26"	\$375
HR07-HR18 and HR65-HR71	<input type="checkbox"/>	Newton Air Grip ² <i>See page 6 for the color selection and price</i>		20", 22", 24", 25", 26"	
HR28	<input type="checkbox"/>	Surge ^{1,2} (1 1/2" Oval handrim w/ Gripton high friction strip)		22", 24", 25", 26"	\$450
HR05	<input type="checkbox"/>	Surge LT ^{1,2} (1 1/8" Oval handrim w/ Gripton high friction strip)		22", 24", 25", 26"	\$495
HR04	<input type="checkbox"/>	Natural Fit ^{1,2}		22", 24", 25", 26"	\$395
HR62	<input type="checkbox"/>	Simi H ^{1,2} (1 1/4" Oval handrim with high friction strip)		22", 24", 25", 26"	\$395
HR63	<input type="checkbox"/>	Nova H ^{1,2} (1 1/4" Oval handrim with high friction strip)		22", 24", 25", 26"	\$445
HR64	<input type="checkbox"/>	Optimum H ^{1,2} (1 1/8" heart-shaped handrim)		22", 24", 25", 26"	\$345
HR99	<input type="checkbox"/>	Omit handrim			NC

1- Only standard and narrow handrim position. By default, the tab won't be cut with the narrow position; 2- Not available with Mag wheels

Handrims option					
ASSEMBLY POSITION					
HR29	<input type="checkbox"/>	Standard Handrim position	Full tab		STD
HR030	<input type="checkbox"/>	Narrow Handrim position no cut	Full tab		NC
HR30	<input type="checkbox"/>	Narrow Handrim position with cut ³	Short tab 2 positions		\$30
HR31	<input type="checkbox"/>	Super Narrow Handrim ³	Short tab 2 positions STD <input type="checkbox"/> Short tab 1 position <input type="checkbox"/>		\$30
THUMB PIECE SELECTION FOR NATURAL FIT, SURGE, SURGE LT HANDRIMS					
HR23	<input type="checkbox"/>	Standard grip			\$95
HR27	<input type="checkbox"/>	Super grip			\$150
HR099	<input type="checkbox"/>	Omit thumb piece			NC

3- Only available with Aluminum and Air Grip handrims;

AXLES					
AX01	<input type="checkbox"/>	Quick release axle			STD
AX03	<input type="checkbox"/>	Quad release axle		K0108	\$130
REAR WHEEL CAMBER					
CM00	<input type="checkbox"/>	0° camber			STD
CM02	<input type="checkbox"/>	2° camber			NC
CM04	<input type="checkbox"/>	4° camber			NC
CM06	<input type="checkbox"/>	6° camber			NC
CM08	<input type="checkbox"/>	8° camber			NC

CENTER OF GRAVITY	
Specify the position of rear wheel axle plate: _____	
Measure distance from front of back post to center of axle receiver.	
0 - 6" range	Set At: _____ (inches)
<i>If not indicated, default setting is at 2.5"</i>	
Motion Composites will select the closest possible center of gravity (COG) if an issue arises with the COG	

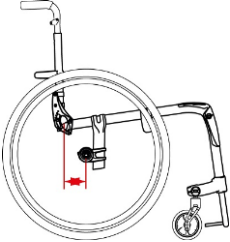

WHEEL LOCK				
WL08	<input type="checkbox"/>	Newton wheel lock - push to lock		STD
WL14	<input type="checkbox"/>	6" removable extension handle for push to lock	E0961	\$77
WL16	<input type="checkbox"/>	Aluminum push to lock with extensions	E0961	\$77
WL02	<input type="checkbox"/>	Pull to lock		NC
WL04	<input type="checkbox"/>	Newton grade aid push to lock <i>(works best with pneumatic or high pressure tire)</i>	E0974	\$155
WL13	<input type="checkbox"/>	6" removable extension handle for pull to lock and grade aid	E0961	\$77
WL05	<input type="checkbox"/>	Scissors lock		\$155
WL99	<input type="checkbox"/>	Omit wheel locks		NC

Armrests				
HEIGHT ADJUSTABLE "T" ARMREST ¹				
AR13-610	<input type="checkbox"/>	10" Desk length armpad ²	6" - 10"	\$330
AR03-812	<input type="checkbox"/>	10" Desk length armpad	8" - 12"	\$330
AR03-1014	<input type="checkbox"/>	10" Desk length armpad	10" - 14"	\$330
AR14-610	<input type="checkbox"/>	14" Full length armpad ³	6" - 10"	\$330
AR04-812	<input type="checkbox"/>	14" Full length armpad	8" - 12"	\$330
AR04-1014	<input type="checkbox"/>	14" Full length armpad	10" - 14"	\$330
HEIGHT ADJUSTABLE SWING AWAY ARMREST ²				
AR05	<input type="checkbox"/>	Tubular armrest without plastic side guards - Short pad	8" - 11"	E0973 \$230
AR19	<input type="checkbox"/>	Tubular armrest with plastic side guards - short pad	8" - 11"	E0973 \$395
AR23	<input type="checkbox"/>	Tubular armrest without plastic side guards - long pad	8" - 11"	E0973 \$230
AR24	<input type="checkbox"/>	Tubular armrest with plastic side guards - long pad	8" - 11"	E0973 \$395
AR06	<input type="checkbox"/>	10" Desk length flat armpad without plastic side guards	8" - 11"	E0973 \$230
AR20	<input type="checkbox"/>	10" Desk length flat armpad with plastic side guards	8" - 11"	E0973 \$395
AR17	<input type="checkbox"/>	14" Full length flat armpad without plastic side guards	8" - 11"	E0973 \$230
AR21	<input type="checkbox"/>	14" Full length flat armpad with plastic side guards	8" - 11"	E0973 \$395
AR99	<input type="checkbox"/>	Omit armrest		NC

1- May have 1/2" adjustment restriction on both limits of the range; 2- not available with the Ultralight non-locking backrest; 3- May have some restriction with seat-to-floor height and rear wheel

SIDE GUARDS (not available with "T" Armrest)				
SG01	<input type="checkbox"/>	Plastic side guards <i>(removable)</i>	K0108	\$200
SG03	<input type="checkbox"/>	Carbon fiber side guards <i>(removable)</i>	K0108	\$305
SG06	<input type="checkbox"/>	Plastic fender side guards - straight bracket <i>(removable)</i>		\$290
SG08	<input type="checkbox"/>	Plastic fender side guards - offset bracket <i>(removable)</i> ¹		\$290
SG04	<input type="checkbox"/>	Carbon fiber fender side guards <i>(removable)</i>	K0108	\$550
SG99	<input type="checkbox"/>	Omit side guards		NC
SIDE GUARDS OPTION				
SG07	<input type="checkbox"/>	Side guard clip <i>(pair)</i>		NC

1- only compatible with 0° and 2° camber; Increase distance between fender side guards by 1 1/8"

POSITIONING BELT				
SB01-S	<input type="checkbox"/>	Velcro adjustable - Standard 35" ¹	E0978	\$46
SB01-L	<input type="checkbox"/>	Velcro adjustable - Long 60"	E0978	\$46
SB02-S	<input type="checkbox"/>	Auto buckle - Standard 35" ¹	E0978	\$87
SB02-L	<input type="checkbox"/>	Auto buckle - Long 60"	E0978	\$87
SB04-M	<input type="checkbox"/>	BodyPoint Hip Belt - 2 point not padded - Medium 56"	E0978	\$85
SB04-L	<input type="checkbox"/>	BodyPoint Hip Belt - 2 point not padded - Long 61"	E0978	\$85
SB05-S	<input type="checkbox"/>	BodyPoint Hip Belt - 2 point padded - Small 51"	E0978	\$180
SB05-M	<input type="checkbox"/>	BodyPoint Hip Belt - 2 point padded - Medium 56"	E0978	\$180
SB05-L	<input type="checkbox"/>	BodyPoint Hip Belt - 2 point padded - Long 61"	E0978	\$180
SB06-S	<input type="checkbox"/>	BodyPoint Hip Belt - 4 point padded - Small 51"	E0978	\$195
SB06-M	<input type="checkbox"/>	BodyPoint Hip Belt - 4 point padded - Medium 56"	E0978	\$195
SB06-L	<input type="checkbox"/>	BodyPoint Hip Belt - 4 point padded - Long 61"	E0978	\$195
SB03	<input type="checkbox"/>	Hardware attachment for 2 extra points (1 pair)		\$17
SB08-M	<input type="checkbox"/>	BodyPoint EVOFLEX® Positioning Belt Rehab latch and Band Clamps - Medium 18"	K0108	\$305
SB08-L	<input type="checkbox"/>	BodyPoint EVOFLEX® Positioning Belt Rehab latch and Band Clamps - Long 24"	K0108	\$305
SB99	<input type="checkbox"/>	Omit positioning belt		STD

1- Not available with wheelchair width of 18" and more

ACCESSORIES									
AC03	<input type="checkbox"/>	Anti-tippers			E0971 \$145				
AC06	<input type="checkbox"/>	Cane and crutch holder	Left <input type="checkbox"/>	Right <input type="checkbox"/>	E2207 \$200				
AC08	<input type="checkbox"/>	Spoke guards ¹	Available: 20", 22", 24", 26"		K0065 \$118				
AC10	<input type="checkbox"/>	Seat pouch			\$82				
AC30	<input type="checkbox"/>	Newton multi-purpose pouch			\$61				
AC26	<input type="checkbox"/>	BodyPoint Mobility Bag			\$135				
AC23	<input type="checkbox"/>	Newton Backpack			\$130				
AC13	<input type="checkbox"/>	Tool kit			\$51				
AC16	<input type="checkbox"/>	Motion Composites Polo Shirt	W/S <input type="checkbox"/>	W/M <input type="checkbox"/>	W/L <input type="checkbox"/>				
			M/S <input type="checkbox"/>	M/M <input type="checkbox"/>	M/L <input type="checkbox"/>	M/XXL <input type="checkbox"/>	M/XXXL <input type="checkbox"/>	\$36	
AC15	<input type="checkbox"/>	Military Patches	Army <input type="checkbox"/>	Navy <input type="checkbox"/>	Air Force <input type="checkbox"/>	Marines <input type="checkbox"/>	Coast Guard <input type="checkbox"/>		\$97
			Combat Wounded Purple Heart <input type="checkbox"/>						

1- Not available with Mag wheels and Spinergy

Colors																					
Options ¹	Black	High Gloss Carbon Fiber	Sunkissed Orange	Burgundy	Sapphire Blue	Monster Green	Charcoal	Fuchsia	Steel Blue	Ferrari Red	Acid Green	Electric Purple	Caribbean Blue	White	Pink Pearl	Plum Purple	Sky Blue	Black Cherry	Khaki Green (matte)	Desert Sand (matte)	
AirGrip	<input type="checkbox"/> \$110	<input type="checkbox"/>	<input type="checkbox"/>	<input type="checkbox"/>	<input type="checkbox"/>	<input type="checkbox"/>	<input type="checkbox"/>	<input type="checkbox"/>	<input type="checkbox"/>	<input type="checkbox"/>	<input type="checkbox"/>	<input type="checkbox"/>	<input type="checkbox"/>	<input type="checkbox"/>	<input type="checkbox"/>	<input type="checkbox"/>	<input type="checkbox"/>	<input type="checkbox"/>	<input type="checkbox"/>	<input type="checkbox"/>	\$265
Carbon Fiber Frame	<input type="checkbox"/>	<input type="checkbox"/> STD	<input type="checkbox"/>	<input type="checkbox"/>	<input type="checkbox"/>	<input type="checkbox"/>	<input type="checkbox"/>	<input type="checkbox"/>	<input type="checkbox"/>	<input type="checkbox"/>	<input type="checkbox"/>	<input type="checkbox"/>	<input type="checkbox"/>	<input type="checkbox"/>	<input type="checkbox"/>	<input type="checkbox"/>	<input type="checkbox"/>	<input type="checkbox"/>	<input type="checkbox"/>	<input type="checkbox"/>	NC
Camber Tube	<input type="checkbox"/> STD/NC	<input type="checkbox"/>	<input type="checkbox"/>	<input type="checkbox"/>	<input type="checkbox"/>	<input type="checkbox"/>	<input type="checkbox"/>	<input type="checkbox"/>	<input type="checkbox"/>	<input type="checkbox"/>	<input type="checkbox"/>	<input type="checkbox"/>	<input type="checkbox"/>	<input type="checkbox"/>	<input type="checkbox"/>	<input type="checkbox"/>	<input type="checkbox"/>	<input type="checkbox"/>	<input type="checkbox"/>	<input type="checkbox"/>	\$60
Highlight ³	<input type="checkbox"/>	<input type="checkbox"/>	<input type="checkbox"/>	<input type="checkbox"/>	<input type="checkbox"/>	<input type="checkbox"/>	<input type="checkbox"/>	<input type="checkbox"/>	<input type="checkbox"/>	<input type="checkbox"/>	<input type="checkbox"/>	<input type="checkbox"/>	<input type="checkbox"/>	<input type="checkbox"/>	<input type="checkbox"/>	<input type="checkbox"/>	<input type="checkbox"/>	<input type="checkbox"/>	<input type="checkbox"/>	<input type="checkbox"/>	NC
FC99 ²	<input type="checkbox"/>	Custom Color	Specify PPG Paintit color:																<i>additional 10 days lead-time</i>	\$390	

1- Color representation may vary from one monitor to another. Therefore, the actual paint color on your wheelchair might differ slightly from what you see on your screen.; Finish between Airgrip and frame might be different;

2- Only available with carbon fiber upgrade; 3- To see different highlight, visit our website:

https://www.motioncomposites.com/en_us/products/rigid-wheelchairs/apex-c

Notes :

 <p>NXCABF _ _ _ _ (W" x D")</p> <p>HCPCS CODE: E2607-E2608</p>	WIDTH										
	DEPTH		12"	13"	14"	15"	16"	17"	18"	19"	20"
	12"	<input type="checkbox"/>	\$445	<input type="checkbox"/>	\$445	<input type="checkbox"/>	\$445				
	14"	<input type="checkbox"/>	\$445	<input type="checkbox"/>	\$445	<input type="checkbox"/>	\$445				
	15"			<input type="checkbox"/>	\$445	<input type="checkbox"/>	\$445	<input type="checkbox"/>	\$445		
	16"			<input type="checkbox"/>	\$445	<input type="checkbox"/>	\$445	<input type="checkbox"/>	\$445	<input type="checkbox"/>	\$480
	17"					<input type="checkbox"/>	\$445	<input type="checkbox"/>	\$445	<input type="checkbox"/>	\$480
	18"					<input type="checkbox"/>	\$445	<input type="checkbox"/>	\$445	<input type="checkbox"/>	\$480
	19"					<input type="checkbox"/>	\$445	<input type="checkbox"/>	\$445	<input type="checkbox"/>	\$480
	20"					<input type="checkbox"/>	\$445	<input type="checkbox"/>	\$445	<input type="checkbox"/>	\$480
Option: Change cover for incontinent/infection control outer cover <input type="checkbox"/> \$N/C											

SEATING AND CUSHION ACCESSORIES

	MODEL NO.	DESCRIPTION	FITS BACK WIDTH	\$	QTY
	RSSI 1600	Solid Seat Insert	Fits cushions 16" & 17" wide (40.6 & 43.2 cm) and 14"-18" deep (35.6-45.7 cm)	80	
	RSSI 1600	Solid Seat Insert	Fits cushions 18" & 19" wide (45.7 & 48.3 cm) and 14"-18" deep (35.6-45.7 cm)	80	
	RSSI 1600	Solid Seat Insert	Fits cushions 20"-22" wide (50.8-55.9 cm) and 18"-20" deep (45.7-50.8 cm)	80	

THORACIC SHAPE



**Optima™
THORACIC BACK SUPPORT**

CARBON FIBER SHELL (WEIGHT SAVINGS - 1lb)
HCPCS CODE: E2620-E2621

WIDTH	HEIGHT	MODEL # CARBON FIBER	\$ CARBON	MODEL # ALUMINUM	\$ ALUMINUM
13"	7"			NOACB1307	<input type="checkbox"/> \$695
13"	9"			NOACB1309	<input type="checkbox"/> \$695
13"	13"			NOACB1313	<input type="checkbox"/> \$695
13"	16"			NOACB1316	<input type="checkbox"/> \$695
14"	7"			NOACB1407	<input type="checkbox"/> \$695
14"	9"	NOFACB1409	<input type="checkbox"/> \$895	NOACB1409	<input type="checkbox"/> \$695
14"	13"	NOFACB1413	<input type="checkbox"/> \$925	NOACB1413	<input type="checkbox"/> \$695
14"	16"	NOFACB1416	<input type="checkbox"/> \$960	NOACB1416	<input type="checkbox"/> \$695
15"	7"			NOACB1507	<input type="checkbox"/> \$695
15"	9"	NOFACB1509	<input type="checkbox"/> \$895	NOACB1509	<input type="checkbox"/> \$695
15"	13"	NOFACB1513	<input type="checkbox"/> \$925	NOACB1513	<input type="checkbox"/> \$695
15"	16"	NOFACB1516	<input type="checkbox"/> \$960	NOACB1516	<input type="checkbox"/> \$695
16"	7"			NOACB1607	<input type="checkbox"/> \$695
16"	9"	NOFACB1609	<input type="checkbox"/> \$895	NOACB1609	<input type="checkbox"/> \$695
16"	13"	NOFACB1613	<input type="checkbox"/> \$925	NOACB1613	<input type="checkbox"/> \$695
16"	16"	NOFACB1616	<input type="checkbox"/> \$960	NOACB1616	<input type="checkbox"/> \$695
17"	7"			NOACB1707	<input type="checkbox"/> \$695
17"	9"	NOFACB1709	<input type="checkbox"/> \$895	NOACB1709	<input type="checkbox"/> \$695
17"	13"	NOFACB1713	<input type="checkbox"/> \$925	NOACB1713	<input type="checkbox"/> \$695
17"	16"	NOFACB1716	<input type="checkbox"/> \$960	NOACB1716	<input type="checkbox"/> \$695
18"	7"			NOACB1807	<input type="checkbox"/> \$695
18"	9"	NOFACB1809	<input type="checkbox"/> \$895	NOACB1809	<input type="checkbox"/> \$695
18"	13"	NOFACB1813	<input type="checkbox"/> \$925	NOACB1813	<input type="checkbox"/> \$695
18"	16"	NOFACB1816	<input type="checkbox"/> \$960	NOACB1816	<input type="checkbox"/> \$695
20"	7"			NOACB2007	<input type="checkbox"/> \$695
20"	9"	NOFACB2009	<input type="checkbox"/> \$895	NOACB2009	<input type="checkbox"/> \$695
20"	13"	NOFACB2013	<input type="checkbox"/> \$925	NOACB2013	<input type="checkbox"/> \$695
20"	16"	NOFACB2016	<input type="checkbox"/> \$960	NOACB2016	<input type="checkbox"/> \$695

ITEM	WIDTH X DEPTH	\$	QTY
Replacement Cover & Foam	NOACC _ _ _ _	130	



**Optima™ DEEP
THORACIC BACK SUPPORT**

CARBON FIBER SHELL (WEIGHT SAVINGS - 1lb)
HCPCS CODE: E2620-E2621

WIDTH	HEIGHT	MODEL # CARBON FIBER	\$ CARBON	MODEL # ALUMINUM	\$ ALUMINUM
13"	7"			NOPCB1307	<input type="checkbox"/> \$695
13"	9"			NOPCB1309	<input type="checkbox"/> \$695
13"	13"			NOPCB1313	<input type="checkbox"/> \$695
13"	16"			NOPCB1316	<input type="checkbox"/> \$695
14"	7"			NOPCB1407	<input type="checkbox"/> \$695
14"	9"	NOCFPCB1409	<input type="checkbox"/> \$995	NOPCB1409	<input type="checkbox"/> \$695
14"	13"	NOCFPCB1413	<input type="checkbox"/> \$1015	NOPCB1413	<input type="checkbox"/> \$695
14"	16"	NOCFPCB1416	<input type="checkbox"/> \$1055	NOPCB1416	<input type="checkbox"/> \$695
15"	7"			NOPCB1507	<input type="checkbox"/> \$695
15"	9"	NOCFPCB1509	<input type="checkbox"/> \$995	NOPCB1509	<input type="checkbox"/> \$695
15"	13"	NOCFPCB1513	<input type="checkbox"/> \$1015	NOPCB1513	<input type="checkbox"/> \$695
15"	16"	NOCFPCB1516	<input type="checkbox"/> \$1055	NOPCB1516	<input type="checkbox"/> \$695
16"	7"			NOPCB1607	<input type="checkbox"/> \$695
16"	9"	NOCFPCB1609	<input type="checkbox"/> \$995	NOPCB1609	<input type="checkbox"/> \$695
16"	13"	NOCFPCB1613	<input type="checkbox"/> \$1015	NOPCB1613	<input type="checkbox"/> \$695
16"	16"	NOCFPCB1616	<input type="checkbox"/> \$1055	NOPCB1616	<input type="checkbox"/> \$695
17"	7"			NOPCB1707	<input type="checkbox"/> \$695
17"	9"	NOCFPCB1709	<input type="checkbox"/> \$995	NOPCB1709	<input type="checkbox"/> \$695
17"	13"	NOCFPCB1713	<input type="checkbox"/> \$1015	NOPCB1713	<input type="checkbox"/> \$695
17"	16"	NOCFPCB1716	<input type="checkbox"/> \$1055	NOPCB1716	<input type="checkbox"/> \$695
18"	7"			NOPCB1807	<input type="checkbox"/> \$695
18"	9"	NOCFPCB1809	<input type="checkbox"/> \$995	NOPCB1809	<input type="checkbox"/> \$695
18"	13"	NOCFPCB1813	<input type="checkbox"/> \$1015	NOPCB1813	<input type="checkbox"/> \$695
18"	16"	NOCFPCB1816	<input type="checkbox"/> \$1055	NOPCB1816	<input type="checkbox"/> \$695
20"	7"			NOPCB2007	<input type="checkbox"/> \$695
20"	9"	NOCFPCB2009	<input type="checkbox"/> \$995	NOPCB2009	<input type="checkbox"/> \$695
20"	13"	NOCFPCB2013	<input type="checkbox"/> \$1015	NOPCB2013	<input type="checkbox"/> \$695
20"	16"	NOCFPCB2016	<input type="checkbox"/> \$1055	NOPCB2016	<input type="checkbox"/> \$695

ITEM	WIDTH X DEPTH	\$	QTY
Replacement Cover & Foam	NOPCC _ _ _ _	130	

PLEASE NOTE: Each back will fit widths up to 2" wider.

BACK SUPPORT HARDWARE OPTIONS

All backs come STANDARD with QuickRelease Mounting Hardware. The following are fixed hardware options available at no charge when ordered with a back support.

Model #	DESCRIPTION	WEIGHT OF HARDWARE ONLY	✓
	QuickFit Quick Release Hardware System	STANDARD (2 LBS)	STANDARD
NIB-1642	Micro Mount 2 point fixed hardware. Back width needs to match chair width	Weight savings of 1.4 lb over STANDARD	<input type="checkbox"/>
NIB-1207	2 point fixed hardware. Width expandable to fit 3 sizes of chair	Weight savings of 1.0 lb over STANDARD	<input type="checkbox"/>

BACK SUPPORT ACCESSORIES

	MODEL #	DESCRIPTION	FITS BACK WIDTH	\$	QTY
	Custom - Cover	Optional Infection Control Wipe Down Back Support Cover	Specify back model # when ordering	205	
	NIB-1938	Extra Small Privacy Flap for 11" - 13" wide back supports	11" - 13" (27.9 - 33.0)	70	
	NIB-1078	Small Privacy Flap for 14"-16" wide back supports	14" - 16" (35.6-40.6 cm)	70	
	NIB-1079	Medium Flap for 17"-19" wide back supports	17" - 19" (43.2-48.3 cm)	70	
	NIB-1080	Large Privacy Flap for 20"-22" wide back supports	20" - 22" (50.8-55.9 cm)	70	
	NIB-1081	Extra Large Privacy Flap for 23" - 26" wide back supports	23" - 26" (58.4 - 66.0 cm)	70	

ALL PRICES QUOTED IN USD. PRICES ARE SUBJECT TO CHANGE WITHOUT NOTICE.

For additional NXT models, sizes and hardware not shown, please refer to the complete NXT Seating Order Form at www.motioncomposites.com